

## PI CONTROLLER FOR CONTROLLING A THREE-PHASE INVERTER OF A PV SYSTEM CONNECTED TO THE ELECTRICAL NETWORK

Sihem BOURI\*, Tariq BOUDAUD\*\*, Tayeb BOUDJELAL\*\*

\*Materials and Renewable Energy Research Unit (URMER), University Aboubekr Belkaid Tlemcen BP 119 - 13000, Algeria,  
E-mail: sihem.bouri@univ-tlemcen.dz

\*\*Department of Electrical and Electronic Engineering, Faculty of Technology, University Aboubekr Belkaid Tlemcen BP 119 - 13000, Algeria,  
E-mails: tariq.boudaoud@univ-tlemcen.dz, tayeb.boudjelal@univ-tlemcen.dz

### ABSTRACT

In order to improve the efficiency of photovoltaic panels it is necessary to introduce the technique of Maximum Power Point (the technique of the MPPT). In the literature, several strategies are mentioned, among which the perturbation and observation (P&O) algorithm. The aim of this work is to a simulation study in MATLAB of a photovoltaic panel connected to the network using DC-DC and DC-AC converters. DC Boost converter is checked by the MPPT command to adjust the output voltage of the photovoltaic panel and maximize the power produced by the photovoltaic panel. The PI controller is used to control the inverter three-phase to make the connection of the photovoltaic panel to a three-phase electrical network.

**Keywords:** PV system, DC boost converter, MPPT command, P&O, three-phase voltage converter, PI regulator

### 1. INTRODUCTION

The renewable energy market has grown rapidly over the past decade due to deteriorating environmental quality and the escalating price of fossil fuels.

Renewable energy has become today like a potential solution for pollution because it is more appropriate and more efficient and clean.

The rapid development of solar energy has gradually appeared in the form of small electrical installations connected to the Low Voltage (LV) network and solar farms directly connected to the Medium and High Voltage (HV, MV) network.

In order to improve the efficiency of photovoltaic panels it is necessary to introduce the technique of the Maximum Power Point (the technique of MPPT). In the literature, several strategies are mentioned, among which the perturbation and observation algorithm (P&O).

The aim of this work consists of a study by simulation under MATLAB of a photovoltaic panel connected to the electrical network using DC-DC and DC-AC converters.

### 2. SUBJECT

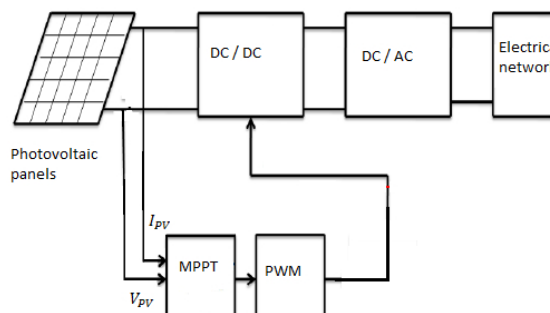
One way to benefit from photovoltaic energy is to connect PV systems into a electrical network. Since most electrical networks operate on AC and PV systems produce electrical energy continuously, this incompatibility can be resolved by converting the electrical energy produced by PV systems from DC to AC using an inverter.

In this paper, we will discuss the modeling and design of a three phase inverter controlled by PI control for our two stage photovoltaic system and how to make it connected in a three phase electrical network considering the characteristics of the electrical network. Since the input source of the inverter is a voltage source we used the three phase voltage inverter.

A general diagram of a PV system connected to the electrical network is shown in Figure 1 and consists of three main components: PV panel (or generator), power

converter (inverter and chopper) and the alternative network. Since the power generated by the photovoltaic panels is direct current, the power converter, which is a technology based on power electronics, is needed to convert the direct current of the photovoltaic panels into alternating current. In other words, the power converter plays an important role in controlling the power supply and at the same time ensuring a good integration between the PV and the network. Additionally, other specifications are imposed by requirements network to make network-connected PV systems more resilient and user-friendly:

- 1- Reliable or secure power supply;
- 2- Flexible control of active and reactive power;
- 3- Dynamic network support as required;
- 4- System status monitoring, protection and communication;
- 5- High efficiency and reliability, low cost and small volume [9].



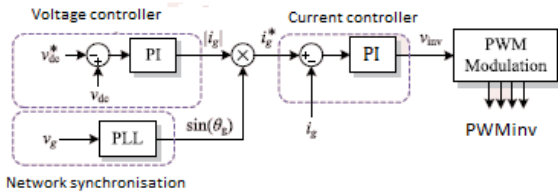
**Fig. 1** General diagram of a PV system connected to the electrical network [22]

The control of the PV system is activated via the power

converter, which acts as an interface between the PV and the network. For the two-stage PV system the first stage dc-dc conversion is responsible for controlling the PV power, while the stage of dc-ac conversion is in charge of network interactivity. From the PV side, the converter dc-regulates the power extracted from the photovoltaic generators by controlling the point of the photovoltaic generator (for example, the photovoltaic voltage) depending on the characteristic  $P(V)$  of the PV. This can be done using a controller proportional-integral (PI) to regulate the voltage of the PV, the reference of which is determined by the MPPT algorithm, to continuously monitor the MPP and maximize energy efficiency during operation.

As the PV power is controlled by the DC-DC converter, the role of the DC-AC conversion is to ensure that the extracted power is supplied to the network. A possible way to do this is to regulate the voltage of the DC link, since the voltage of the continuous link must be kept constant when the continuous supply and the alternative diet are balanced. In doing so, the output of the voltage controller continuous link will give a required amplitude of the network current, depending on the difference between the reference and the measured DC link voltage. Then the current reference network  $I_r$  can be obtained by multiplying the amplitude of the network current  $I_r$  by  $\sin(\theta_r)$ , where  $\theta_r$  is the phase angle of the network voltage supplied by a loop a phase lock (PLL) [9].

The functional diagram of the VSI control in the reference dq is illustrated in figure 2.



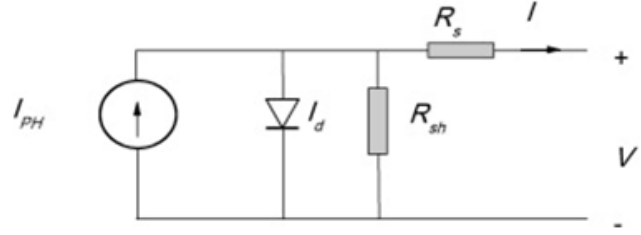
**Fig. 2** Functional diagram of VSI control in reference dq

The PLL is adopted to provide the phase information of the network voltage, which is needed to transform the network currents into their components  $dq$   $I_d$  and  $I_q$  in the  $dq$  coordinate system, and then transform the voltage control signal back into the  $abc$  mark.

### 3. METHODS

#### 3.1. PV system

To model a photovoltaic system we will use the single diode model which is one of the most used models. This model includes a combination of a photo-generated controlled current source  $I_{PH}$ , a diode  $D$  described by the single exponential Shockley equation and a shunt resistor  $R_{sh}$  and a series resistor  $R_s$  modeling the power losses. The equivalent circuit of a photovoltaic system is given in Figure 3:



**Fig. 3** Equivalent circuit of a PV system

From Kirchhoff's law the current delivered by the photovoltaic cell is given as follows:

$$I = I_{PH} - I_d - I_{sh} \quad (1)$$

The parallel branch current described as follows:

$$I_{sh} = \frac{V + R_s I}{R_{sh}} = \frac{V_d}{R_{sh}} \quad (2)$$

The current flowing through the diode described as follows:

$$I_d = I_s \left( e^{\frac{V_d}{nV_t}} - 1 \right) \quad (3)$$

Where :

$I_s$  : the inverse saturation current

$n$  the ideality factor of the diode

$V_t$  : the thermal voltage which is given by the following relation:

$$V_t = \frac{N_s k T_c}{q} \quad (4)$$

Where :

$k$  : Boltzmann constant ( $1,380650 \times 10^{-23} \text{ J/K}$ )

$q$  : the electronic charge ( $1,602176 \times 10^{-19} \text{ C}$ )

$N_s$  : the number of cells connected in series.

The inverse saturation current  $I_s$  is given by the following equation:

$$I_s = I_{sn} \left( \frac{T_c}{T_{ref}} \right)^3 e^{\left( \frac{E_{g0} \left( \frac{1}{T_n} - \frac{1}{T_c} \right)}{nk} \right)} \quad (5)$$

The saturation current  $I_{sn}$  is given by the following relation:

$$I_{sn} = \frac{I_{cc}}{e^{\left( \frac{V_{co}}{nV_t} \right)} - 1} \quad (6)$$

Where :

$I_{cc}$  : short circuit current of the solar cell

$V_{co}$  : open circuit voltage of the solar cell

$E_{g0}$  : the energy band gap of the semiconductor.

The photo-generated current  $I_{PH}$  can be evaluated for any arbitrary value of irradiance  $G$  and cell temperature  $T_c$  using the following equation:

$$I_{PH} = \frac{G}{G_{ref}} I_{cc} + k_i (T_c - T_{ref}) \quad (7)$$

Where :

$G_{ref}$  : the irradiance

$T_{ref}$  : the temperature of the cell at standard test conditions

$k_i (A/^{\circ}C)$  : the temperature coefficient of the current

$I_{cc}$  : the short circuit current of the solar cell at standard test

conditions (STC).

So the output current of a PV  $I$  system is described as follows:

$$I = I_{PH} - I_s \left( e^{\left( \frac{V_d}{nV_t} \right)} - 1 \right) - \frac{V_d}{R_{sh}} \quad (8)$$

### 3.2. DC Boost Converter

The parallel chopper is also called booster chopper is a static converter that allows to provide an output voltage whose average value is greater than that of the input voltage [12].

The Parallel Chopper circuit is illustrated in figure 4. Its output voltage  $V_o$  is always greater than the input voltage  $V_s$  for steady-state operation.

The Parallel Chopper consists of an inductor  $L$ , a controlled switch  $S$  (usually an IGBT or MOSFET), a diode  $D$ , a filter capacitor  $C$  and a load resistor  $R$ . switch  $S$  is activated and deactivated at the switching frequency  $f_s = \text{frac}1T$  with the duty cycle  $\alpha = \text{frac}tonT$ , where  $ton$  is the time interval when the switch  $S$  is on and  $\alpha$  between 0 and 1.

The Parallel Chopper can operate in continuous or discontinuous conduction mode, depending on the current waveform of the inductor. The Parallel Chopper in discontinuous conduction mode cannot operate at  $R = \infty$  because the filter capacitor has no path to discharge [13].

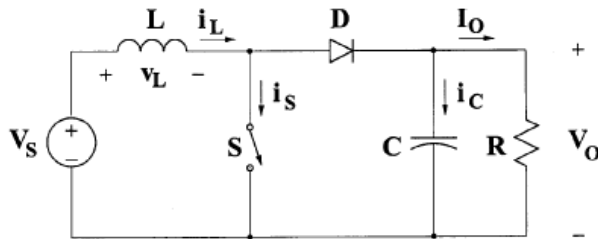


Fig. 4 Ideal equivalent circuit of the parallel chopper [14]

Our goal is to design a parallel chopper for which to use its output voltage as an input in a three-phase inverter to convert from direct to alternating and for that the output voltage that we want is follows the voltage of our electrical network which is  $V_o = 400V$ .

The input quantities that we will use in our chopper will be the maximum operating quantities of the PV in STC as illustrated in table 1.

The desired ripple value for the current in the inductor  $i_L$  is 5 % and 1 % for the output voltage  $V_o$ .

The switching frequency we are going to use is  $f_s = 16KHz$ .

The duty cycle is:

$$\alpha = 1 - \frac{V_{Pm}}{V_o} = 1 - \frac{31.3}{400} = 0.922$$

The load resistor:

$$R = 1 - \frac{V_o^2}{P_m} = \frac{400^2}{270} = 592.6\Omega$$

The current  $i_L$ :

$$i_L = \frac{P}{V_o} = \frac{270}{400} = 0.68A$$

The ripples:

$$\Delta i_L = 0.05 \times i_L = 0.05 \times 0.68 = 0.034A$$

$$\Delta v_0 = 0.01 \times V_o = 0.01 \times 400 = 4V$$

To find the minimum values of the inductance  $L$  and the capacitor  $C$  we will use the equations:

$$L_{min} = \frac{V_{Pm}\alpha}{f_s\Delta i_L} = \frac{31.3 \times 0.922}{16 \times 10^3 \times 0.034} = 0.053H$$

$$C_{min} = \frac{V_o\alpha}{f_s R \Delta v_0} = \frac{400 \times 0.922}{16 \times 10^3 \times 592.6 \times 4} = 9.7\mu F$$

### 3.3. MPPT command

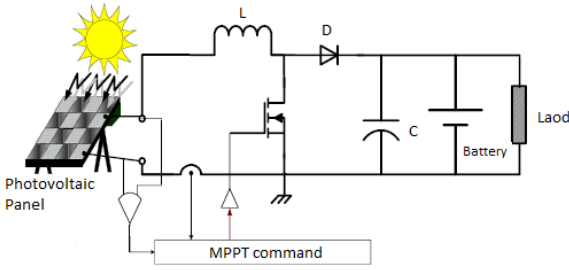
By definition, an MPPT command, associated with an intermediate adaptation stage, makes it possible to operate a PV so as to continuously produce the maximum of its power whatever the weather conditions (temperature and radiation), the MPPT command of the converter places the system at the maximum operating point (VPPM and IPPM). The MPPT control varies the duty cycle of the static converter, using an appropriate electrical signal, to get the maximum power that the PV can deliver. The MPPT algorithm can be more or less complicated to find the MPP. In general, it is based on the variation of the duty cycle of the static converter as a function of the evolution of the input parameters of the latter ( $I$  and  $V$  and consequently of the power of the PV) until it is placed on the MPP [16].

The MPPT needs a fast and intelligent control system to counter rapidly changing weather data or load changes [9].

The purpose of the DC to DC converter is to isolate the DC input from the DC output so that the output can be adjusted for maximum power. The MPPT command typically uses a [17] microprocessor.

The MPPT control consists of two basic components, the dc-dc converter and its controller. As shown in Fig 5.

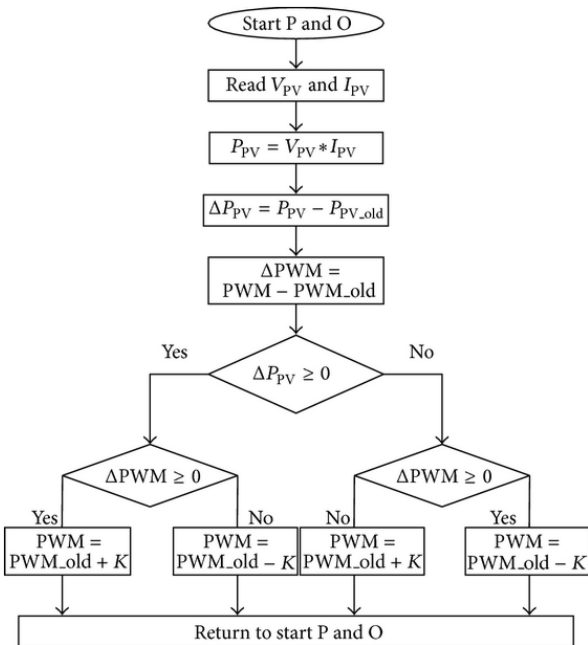
Many techniques have been introduced to catch MPP. These techniques differ by their complexity, their cost, their efficiency, their response and their robustness, among these techniques the most used is the technique of  $P\&O$  (perturbation and observation).



**Fig. 5** Photovoltaic system controlled by the MPPT command [9]

The perturbation and observation technique or algorithm (*P&O*) a procedure in which one variable is changed (disturbed) and the effect of the change on another variable is monitored (observed). (*P&O* is also known as the escalation method).

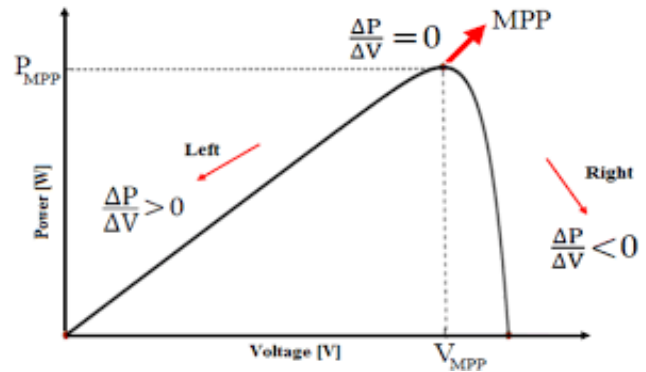
The *P&O* technique is a widely used approach in MPPT research because it is simple and only requires voltage and current measurements of the photovoltaic panel  $V_{PV}$  and  $I_{PV}$  respectively, it can track the maximum power point even when variations in illumination and temperature. The advantage of this method is that it has the particularity of having a simple regulatory structure, and few parameters measured. It can deduce the maximum power point even during variations in illumination and temperature, for all these reasons, the *P&O* method has become an extended approach in MPPT research. [8]



**Fig. 6** Flowchart of the *P&O* algorithm

If  $\Delta P > 0$  then the voltage disturbance moves the operating point to a point closer to the MPP and we continue to disturb the voltage in the same direction this will move the operating point until reaching the MPP.

If  $\Delta P < 0$  the operating point moves away from the PPM then we disturb the voltage with an algebraic sign opposite to the previous sign to move the operating point until reaching the MPP.

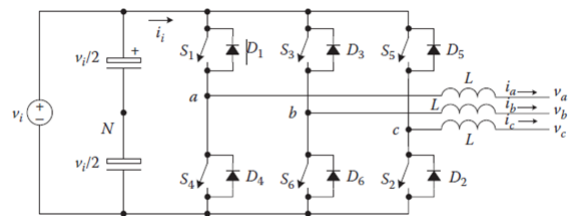


**Fig. 7** Principle of operation of the *P&O* method

### 3.4. Three-phase voltage inverter

Three-phase voltage inverter is mainly used to convert constant DC voltage to AC voltage with variable amplitude and frequency. Figure 8 shows a schematic diagram of a three phase voltage inverter. It is made up of six switches  $S_1 - S_6$  with each phase output connected to the middle of each branch of the inverter. Its three branches are normally delayed by an angle of  $120^\circ$  in order to generate a three-phase AC power supply. The inverter switches each have a 50% ratio and switching occurs after every  $T/6$  of the time. Switches  $S_1$  and  $S_4$ , switches  $S_2$  and  $S_5$ , and switches  $S_3$  and  $S_6$  complement each other.

In the simplest form, three reference signals are compared to a high frequency carrier waveform (PWM) to control the output AC voltage of the inverter. The result of this comparison in each leg is used to turn the switches on or off. It should be noted that the switches in each branch must be actuated interchangeably, in order to avoid a short circuit to the DC power supply [18], [19].



**Fig. 8** Electrical diagram of a three-phase voltage inverter [18]

$V_a, V_b$  and  $V_c$  are the output voltages of the inverter,  $i_a, i_b$  and  $i_c$  are the output currents of the inverter.

The LC filter output voltages and currents are labeled as  $V_{af}, V_{bf}, V_{cf}$  and  $i_{La}, i_{Lb}, i_{Lc}$ . Since the output of the inverter is periodic, the voltage and current dynamics of the

LC filter can be written to the d-q reference as follows:

$$C_f \frac{d}{dt} V_{Cd} = C_f \omega V_{Cq} + i_d - i_{Ld} \quad (9)$$

$$C_f \frac{d}{dt} V_{Cq} = C_f \omega V_{Cd} + i_q - i_{Lq} \quad (10)$$

$$L_f \frac{d}{dt} i_d = -r_f i_d + L_f \omega i_q + V_d - V_{Cd} \quad (11)$$

$$L_f \frac{d}{dt} i_q = -r_f i_q + L_f \omega i_d + V_q - V_{Cq} \quad (12)$$

where  $C_f$  is the capacitance of the filter,  $L_f$  is the inductance of the filter,  $r_f$  is the resistor of the inductance of the filter and  $\omega$  is the angular frequency.

After some mathematical manipulation, the equations 9 and 12 are rewritten in the following compact form:

$$C_f \dot{V}_C = C_f W_{ss} V_c + I - I_L \quad (13)$$

$$L_f \dot{I} = -r_f I + L_f W_{ss} I + U - V_C \quad (14)$$

where  $V_C(t)$ ,  $I_L(t)$ ,  $I(t)$ ,  $U(t)$  represent respectively the load voltage, the load current, the input current of the LC filter and I command entry, defined as:

$$V_C = \begin{bmatrix} V_{Cd} \\ V_{Cq} \end{bmatrix}, I_L = \begin{bmatrix} i_{Ld} \\ i_{Lq} \end{bmatrix}, I = \begin{bmatrix} I_d \\ I_q \end{bmatrix}, U = \begin{bmatrix} V_d \\ V_q \end{bmatrix} \quad (15)$$

where  $W_{ss}$  is an auxiliary antisymmetric matrix defined as follows:

$$W_{ss} = \begin{bmatrix} 0 & \omega \\ -\omega & 0 \end{bmatrix} \quad (16)$$

### 3.5. PI regulator implementation

The model of the inverter with corrector can be derived from the single-phase diagram of the inverter (Figure 9 which mainly consists of the inverter's LCL filter.

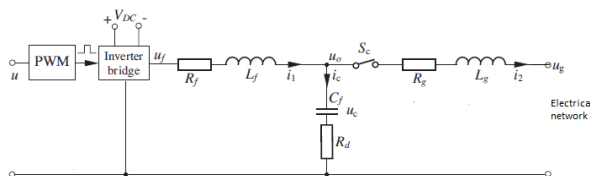


Fig. 9 Representation of a single phase of the inverter [20]

According to Kirchhoff's law we have: the current  $i$  is expressed by:

$$i_c = i_1 - i_2 \quad (17)$$

the voltage  $u_f$  and  $u_g$  is expressed by:

$$u_f = i_1(R_f + sL_f) + i_c \left( \frac{1}{sC_f} + R_d \right) \quad (18)$$

$$u_g = i_1(R_g + sL_g) + i_c \left( \frac{1}{sC_f} + R_d \right) \quad (19)$$

where  $s$  is the Laplace operator. Rewrite the equation 17 and 19 in terms of impedances, then:

$$\begin{bmatrix} u_f \\ u_g \end{bmatrix} = \begin{bmatrix} Z_{11} & -Z_{12} \\ Z_{21} & -Z_{22} \end{bmatrix} \begin{bmatrix} i_1 \\ i_2 \end{bmatrix} \quad (20)$$

With:

$$Z_{11} = R_f + sL_f + R_d + \frac{1}{sC_f} \quad (21)$$

$$Z_{12} = R_d + \frac{1}{sC_f} \quad (22)$$

$$Z_{21} = R_d + \frac{1}{sC_f} \quad (23)$$

$$Z_{22} = R_g + sL_g + R_d + \frac{1}{sC_f} \quad (24)$$

For the PI corrector, there are two parameters  $K_p$  and  $K_i$ . These parameters can be determined using the ziegler and nichols method.

The transfer function of the closed loop system in the discrete time domain is given by:

$$G_{BF}(z) = \frac{C_{PI}(z)H_{sys}(z)}{1 + C_{PI}(z)H_{sys}(z)} \quad (25)$$

subsection Principle of the Ziegler and Nichols method: This method is a semi-empirical method that allows to calculate suitable values for the various parameters in type P, PI and PID correctors. The principle consists in bringing, by increasing the gain of an uncorrected system, to the oscillation limit. We measure the period  $T_0$  of the oscillations and the corresponding added static gain  $K_0$ . Then we use the table 1 to calculate the coefficients of the correctors [21].

The general form of the PID corrector is given by:

$$C_{PID} = K_P \left( 1 + \frac{1}{T_I s} + T_D s \right) \quad (26)$$

Table 1 Table of the Ziegler and Nichols method

Corrector type	$K_P$	$T_I$	$T_D$
P Corrector	$0.5 K_0$	-	-
PI Corrector	$0.45 K_0$	$0.8 T_0$	-
PID Corrector	$0.6 K_0$	$0.5 T_0$	$0.125 T_0$

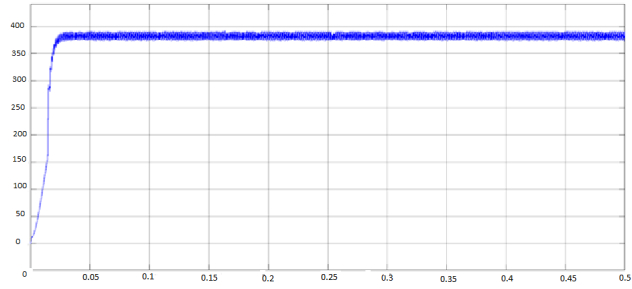
4. RESULTS

To do our simulation we will use the Simulink tool in the MATLAB software.

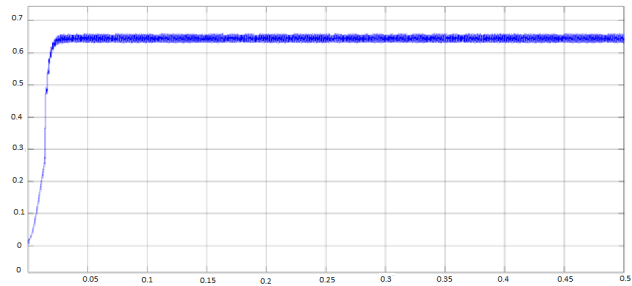
In this simulation we will use the *SRP – 270 – 6PB – HV* module its electrical characteristics at STC (irradiance  $1000W/m^2$  and module temperature  $25^{\circ}$ ) are shown in the table 2:

**Table 2** electrical characteristics of SRP-270-6PB-HV at STC [12]

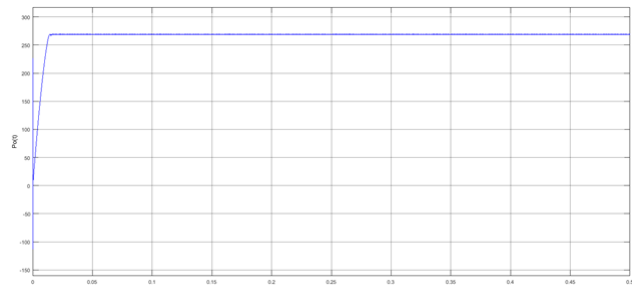
greatness	Values
Maximum power $P_{mp}$	270 W
Open circuit voltage $V_{co}$	39.1 V
Short- circuit current $I_{cc}$	8.99 A
Maximum supply voltage $V_{Pm}$	31.3V
Maximum power current $I_{Pm}$	8.63A
Maximum efficiency $\eta_m$	16.6%
Temperature coefficient of $P_{max}$	$-0.35\%/^{\circ}C$
Temperature coefficient of $V_{co}$	$-0.27\%/^{\circ}C$
Temperature coefficient of $I_{cc}$	$0.05\%/^{\circ}C$
Operating temperature	$-40 \sim +85^{\circ}C$
Nominal operating temperature of the cell	$45 \pm 2^{\circ}C$



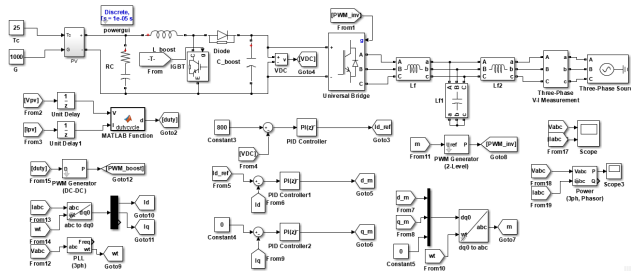
**Fig. 11** The output voltage  $V_o(t)$  of the parallel chopper controlled by MPPT.



**Fig. 12** The output current  $I_o(t)$  of the parallel chopper controlled by MPPT

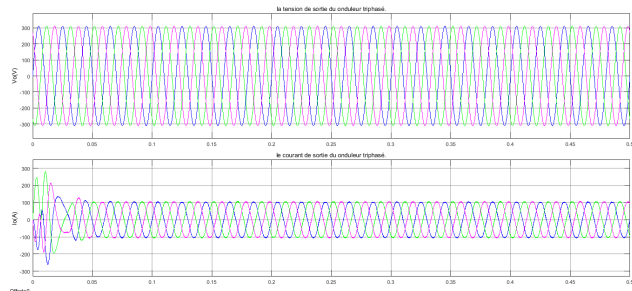


**Fig. 13** the output power of the three-phase inverter  $P_o(t)$



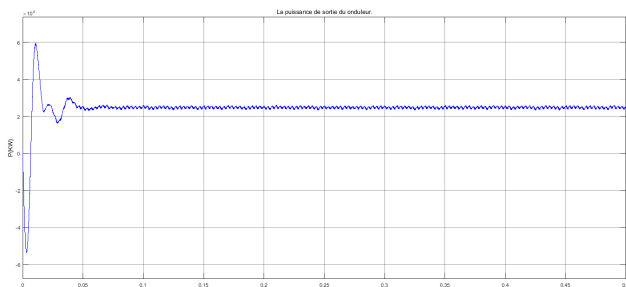
**Fig. 10** Simulation scheme

the characteristics of the inverter output are shown in the following figures:

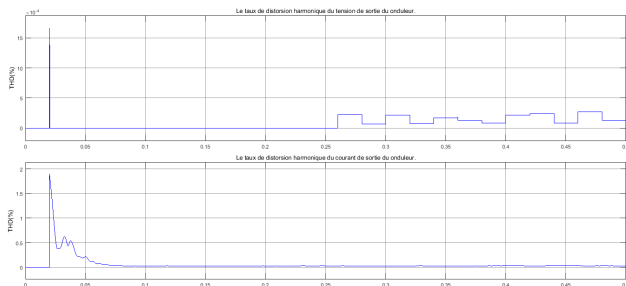


**Fig. 14** The output voltage  $V_o(t)$  and current  $I_o(t)$  of the three-phase inverter

The characteristics of output voltage  $V_o$ , output current  $I_o$  and output power  $P_o$  are shown in the following figures:



**Fig. 15** The output power  $P_o(t)$  of the parallel chopper controlled by MPPT



**Fig. 16** The harmonic distortion rate of the output current and voltage of the inverter

We can observed that the LCL filter to improve the form of the voltage and current supplied to the electrical network

## REFERENCES

- [1] BOUZEGANE, M. – GAOUAOUI, F.: Alimentation dun moteur à courant continu par une source photovoltaïque Thèse de Master, Université Mouloud Mammeri, Tizi-Ouzou, 2018
- [2] BELAKEHAL, S.: Conception & Commande des Machines à Aimants Permanents Dédiées aux Energies Renouvelables, Thèse de Doctorat, Université, Constantine, 2010
- [3] MEFLAH, A.: Modélisation et commande d'une chaine de pompage photovoltaïque, Thèse de Magister, Université Abou Bekr Belkaid, Tlemcen, 2012
- [4] BENSACI, W.: Modélisation et simulation d'un système photovoltaïque adapté par une commande MPPT Thèse de Master, Université Kasdi Merbah, Ouargla, 2012
- [5] HANANOU, F. – ROUBAH, A.: Modélisation et simulation d'un système photovoltaïque, Mémoire de Master, Université Kasdi Merbah, Ouargla, 2014
- [6] SLAMA, F.: Modélisation d'un système multi générateurs photovoltaïques interconnectés au réseau électrique, Thèse de Magister, Université Ferhat Abbas, Setif, 2011

by the three-phase inverter, it is well sinusoidal and balanced.

We notice that the output current and voltage, according to their paces and their spectral analyzes, are of good quality and the TDH is low, the harmonics are all practically negligible compared to the fundamental.

## 5. CONCLUSIONS

the work presented in this paper concerns photovoltaic systems connected by an electrical network. this system is led to experience significant developments mainly linked to an increasingly manifested desire to diversify production means, better respect for the environment and better management of electrical energy in a context of sustainable development .

The synchronization of the currents is made using a three-phase digital PLL in the objective of reconstituting information on the direct component of the fundamental network voltage then injecting into a PI regulation loop thus the phase shift of the three-phase source at the output of the inverter.

The voltage and the current at the output of the three-phase inverter are indeed sinusoidal with weak harmonics which are practically negligible compared to the fundamental

## ACKNOWLEDGEMENT

The author Sihem Bouri thanks to Boudjlal, T. and Boudaoud, T. for their contribution in the this paper.

- [7] La cellule photovoltaïque comment Cca marche, <https://www.planete-energies.com/fr/medias/decryptages/la-cellule-photovoltaïque-comment-ca-marche>
- [8] CHOHRAOUI, H.: Modélisation et simulation d'un système photovoltaïque connecté au réseau, Mémoire de Master, Université Abou Bekr Belkaid, Tlemcen, 2016
- [9] YAHYAOU, I.: Advances in Renewable Energies, vol. 1: Solar and Wind Energies, 2018
- [10] Connecting-solar-panels-together, <https://www.alternative-energy-tutorials.com/solar-power/connecting-solar-panels-together.html>.
- [11] SRP-270-6PB-HV datasheet, <https://fr.enfsolar.com/pv/panel-datasheet/crystalline/40082>.
- [12] BOUKERCHE, G.: Etude et Synthèse d'un Contrôleur PI et Application, Mémoire de Master, Université Badji Mokhtari, Annaba, 2017
- [13] KAZIMIERCZUK, M. K.: Pulse-width Modulated DCDC Power Converters, 2008
- [14] RASHID, M. H.: Power electronics handbook, 2001
- [15] ERICKSON, R. W. – MAKSIMOVIC, D.: Fundamentals of Power Electronics Second edition, 2001
- [16] HAKOUMI, A.: Commande MPPT et contrôle d'un système photovoltaïque 3KW par la logique floue, Mémoire de Master, Université Ahmed Draia, Adrar, 2019
- [17] Maximum Power Point Tracking (MPPT) Charge Controller Working Principle, <https://www.researchgate.net/publication/312222222>

[//electricalacademia.com/renewable-energy/maximum-power-point-tracking-mppt-charge-controller-working-principle/](http://electricalacademia.com/renewable-energy/maximum-power-point-tracking-mppt-charge-controller-working-principle/)

- [18] FANG, L. – HONG, Y.: Advanced DC/AC Inverters: Applications in Renewable Energy, 2013
- [19] QING-CHANG, Z. – HORNIK, T.: Control of power inverters in renewable energy and smart grid integration, 2013
- [20] CHITTI BABU, B.: Control of Voltage Source Inverters using PWM/SVPWM, Department of Electrical Engineering, National Institute of Technology Rourkela, 2009
- [21] Systèmes de contrôle en boucle fermée, [http://public.iutenligne.net/automatique-et-automatismes-industriels/weber/cours\\_au\\_xao\\_jw/chapitre6/chap65.html](http://public.iutenligne.net/automatique-et-automatismes-industriels/weber/cours_au_xao_jw/chapitre6/chap65.html)
- [22] Design and Investigation of Short Circuit Current Based Maximum Power Point Tracking for Photovoltaic System - Scientific, [https://www.researchgate.net/figure/System-Configuration-of-PV-System\\_fig1\\_229045392](https://www.researchgate.net/figure/System-Configuration-of-PV-System_fig1_229045392)

Received September 20, 2021, accepted November 11, 2021

## BIOGRAPHIES

**Sihem Bouri** was born in Ain Tmouchent (Algeria), on August 4, 1976. She graduated the Faculty of Technology, Sidi Bel Abess (Algeria), in 1999. She received the PhD degree in electrical engineering from the Faculty of Technology, Sidi Bel Abess (Algeria), in 2008. She is Professor at the Faculty of Technology, in Tlemcen (Algeria). Her research interests concern: power systems, renewable energy.

**Tariq Boudaoud** was born on 1997 in Tlemcen (Algeria). He has a Masters degree in Electrical Engineering from the Faculty of Technology, University Abou Bekr Belkaid, Tlemcen, Algeria.

**Tayeb Boudjelal** was born on 1997 in Tlemcen (Algeria). He has a Masters degree in Electrical Engineering from the Faculty of Technology, University Abou Bekr Belkaid, Tlemcen, Algeria.